

# Digital Temperature Controller **CB Series**



**CB100    CB700**  
**CB400    CB900**  
**CB500**



## General Description

The CB Series combines easy-to-use operation with the latest temperature control advances at a competitive price. With powerful new features such as RKC's new self-tuning for precise automatic control, digital communications for networking, IP66 (IP65) for waterproof/dustproof protection and heater and loop break alarm capabilities to detect system failures, these controllers deliver exceptional process performance for the most demanding industrial applications.

## Features

- ☆ Bright, easy-to-read LED Displays
- ☆ Advanced self-tuning
- ☆ Digital communications
- ☆ Heat/Cool action
- ☆ Heater/Loop break alarms
- ☆ IP66 (65) - Waterproof/dustproof protection

### Bright, Easy-To-Read LED Displays

The CB Series features large, bright LED displays that have been designed to be easy-to-read from greater distances.

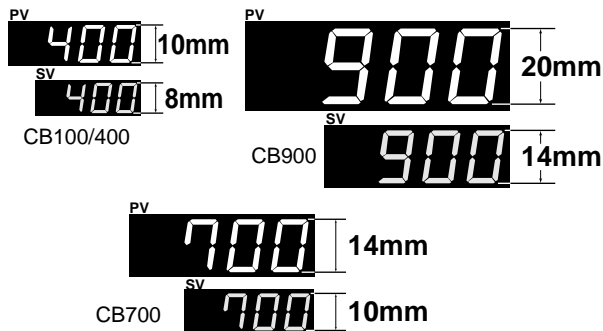

### Self-Tuning Algorithm

The CB Series offers a new self-tuning feature that is initiated at start-up and when process parameters or conditions change. In these situations, the controller evaluates whether the preset PID parameters should be maintained or replaced by the latest self-tuning parameters to achieve the best control for the process. Self-tuning can be manually turned ON/OFF in the parameter setting mode. This feature is not available with the Heat/Cool control.

In addition to self-tuning, The CB Series has standard autotuning (AT) so that either function can be selected to achieve optimum process control.

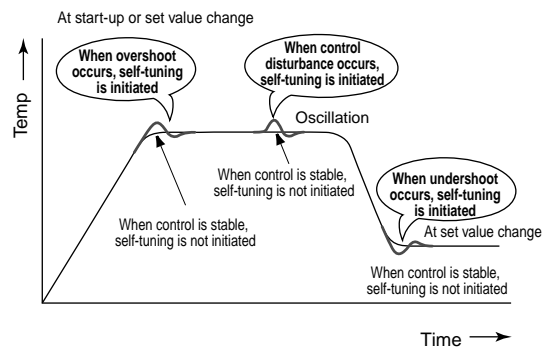

### Digital Communications (Optional)

The CB series offers an optional RS-485 communications interface for networking to computers, PLCs and SCADA software in your plant. Up to 31 units can be interfaced on one RS-485 communication line. MODBUS protocol is also available.

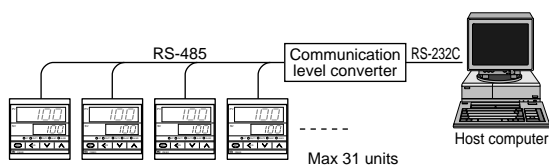

### Heat/Cool Control (Optional)

The Heat/Cool PID control features heat and cool outputs for use where process-generated heat exists. This allows the input of overlap or deadband settings which contribute to energy savings.

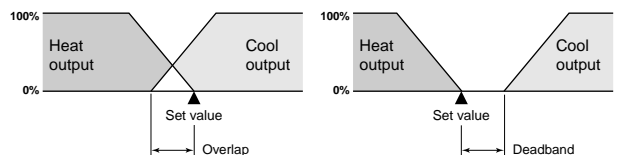

# Digital Temperature Controller CB Series

## Features

### Heater Break Alarm (HBA) (Optional)

The HBA detects a fault in the heating or cooling circuit and displays actual amperage on the display on the front panel. If the measured value becomes lower than the preset value, the alarm is activated.

The HBA function requires a current detector for measuring and monitoring the current load.

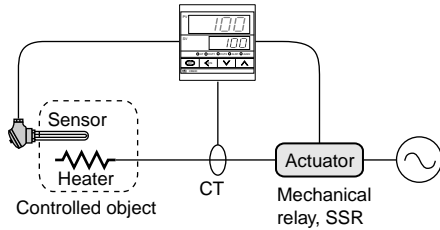

CTL-6-P-N (0 to 30A)	CTL-12-S56-10L-N (0 to 100A)
Length of lead wire : Approx. 130mm (standard)	Length of lead wire : Approx. 100mm (standard)
 φ 5.8	 φ 12

### Loop Break Alarm (LBA) (Optional)

The loop break alarm (LBA) monitors and protects an entire temperature control system. The LBA detects heater breaks, thermocouple or RTD failures, short circuits, or the failure of an operating device such as a mechanical or solid state relay.

When the PID computed value reaches 100% and the temperature does not respond in a set time, the loop break alarm is activated. Conversely, when the PID value reaches 0% and the temperature does not respond accordingly, the loop break alarm is turned on. In this example, the LBA uses reverse action to control heat. For cool control, the LBA action is reversed and becomes direct. LBA deadband is available to suppress the influence of external disturbances.

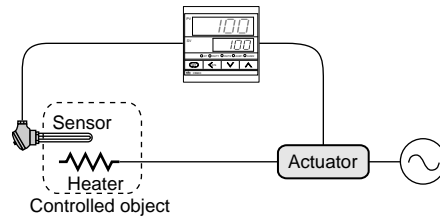

### Temperature Alarms (Optional)

The CB Series provides a wide selection of alarm types to configure up to two alarm contacts. The alarm Hold action is configured in the controller. The alarm action is suppressed by the Hold function at start-up until the process value has entered the non-alarm range.

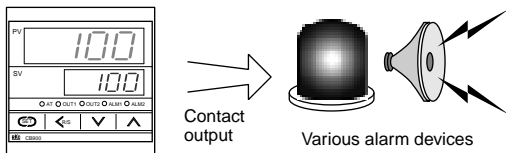

### RUN/STOP Mode (Optional)

When it is necessary to turn off the control output, the STOP mode is available to suspend control operation. To go between these two modes, it is necessary to press the R/S key for one second. When the control output is turned back on, the controller returns to normal operation. The instrument monitors the process value in the lower display in the STOP mode.

The RUN/STOP feature can be enabled/disabled in the parameter setting mode.

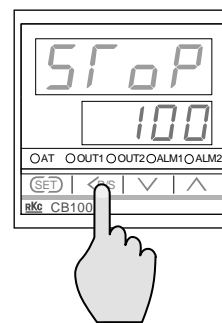

### Close Horizontal Mounting

The CB Series has been designed with a unique mounting bracket that allows close horizontal mounting of multiple instruments to save valuable panel space.

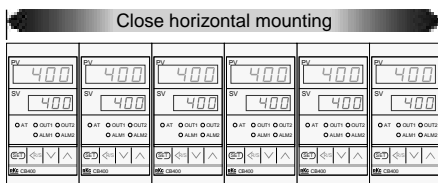

### Waterproof/Dustproof (Optional)

For operation in severe environments or when washdown is required, the IP66(65) rating is available for waterproof/dustproof protection.

## Specifications

### Input

#### Input

- a) Thermocouple : K, J, R, S, B, E, T, N (JIS/IEC), PLII (NBS) W5Re/W26Re (ASTM), U, L (DIN)
- Influence of external resistance : Approx. 0.2 $\mu$ V/ $\Omega$
  - Input break action : Up-scale
- b) RTD : Pt100 (JIS/IEC), JPt100 (JIS)
- Influence of input lead resistance : Approx. 0.01[%/ $\Omega$ ] of reading
  - Maximum 10 $\Omega$  per wire
  - Input break action : Up-scale
- c) DC voltage : 0 to 5V, 1 to 5V (0.0 to 100.0% fixed)
- Input break action : Down scale
- d) DC current : 0 to 20mA, 4 to 20mA (0.0 to 100.0% fixed)
- For DC current input, connect a 250  $\Omega$  resistor to the input terminals.
  - Input break action : Down-scale

#### Sampling Time

0.5 sec

#### PV Bias

Temperature input : -1999(-199.9) to 9999(999.9) $^{\circ}$ C[ $^{\circ}$ F]  
DC voltage, DC current : - span to +span

### Performance

#### Measuring Accuracy

- a) Thermocouple
- ±(0.3% of reading + 1 digit) or  $\pm 2^{\circ}$ C (4 $^{\circ}$ F) whichever is larger
  - Accuracy is not guaranteed between 0 and 399 $^{\circ}$ C (0 and 749 $^{\circ}$ F) for type R, S and B.
  - Accuracy is not guaranteed between -199.9 and -100.0 $^{\circ}$ C (-199.9 and -158.0 $^{\circ}$ F) for type T and U.
- b) RTD
- ±(0.3% of reading + 1 digit) or  $\pm 0.8^{\circ}$ C (1.6 $^{\circ}$ F) whichever is larger
- c) DC voltage and DC current
- ±(0.3% of span + 1 digit)

#### Insulation Resistance

More than 20M $\Omega$  (500V DC) between measured terminals and ground  
More than 20M $\Omega$  (500V DC) between power terminals and ground

#### Dielectric Strength

1000V AC for one minute between measured terminals and ground  
1500V AC for one minute between power terminals and ground

### Control

#### Control Method

- a) PID control (with autotuning and self-tuning function)
- Available for reverse and direct action. (Specify when ordering.)
- b) Heat/Cool PID control (with autotuning function)
- Air and water cooling types are available. (Specify when ordering.)

#### Major Setting Range

Set value : Same as input range.  
Heat side proportional band : 1 to span or 0.1 to span (Temperature input)  
When 0.1 $^{\circ}$ C ( $^{\circ}$ F) resolution, within 999.9 $^{\circ}$ C ( $^{\circ}$ F) or 0.1 to 100.0% of span (voltage, current input) (ON/OFF action when P=0)

- Differential gap at ON/OFF action is 2 $^{\circ}$ C ( $^{\circ}$ F).

Cool side proportional band : 0 to 1000% of heat side proportional band (Heat/Cool ON/OFF action when P<sub>c</sub>=0)

Integral time : 0 to 3600sec.(P + D action when I=0)  
Derivative time : 0 to 3600sec.(P + I action when D=0)  
Anti-Reset Windup(ARW) : 1 to 100% of heat side proportional band  
Deadband/Overlap : -10 to 10 $^{\circ}$ C ( $^{\circ}$ F) or -10.0 to 10.0 $^{\circ}$ C ( $^{\circ}$ F)  
-10.0 to +10.0% of span (Voltage, current input)  
Proportional cycle time : 1 to 100 sec.

#### Control Output

Relay output : Form C contact, 250V AC 3A (resistive load) (Form A contact : Heat/Cool PID type)

Voltage pulse output : 0/12V DC  
(Load resistance : More than 600 $\Omega$ )

Current output : 4 to 20mA DC  
(Load resistance : Less than 600 $\Omega$ )

Triac trigger output : Zero-cross method for medium capacity triac drive (less than 100A)

- Not available for Heat/Cool PID type.

Triac output : Rating : 0.5A  
(An ambient temperature is less than 40 $^{\circ}$ C)

### Alarm (Up to 2 points)

(Optional)

#### Temperature Alarm

- a) Type : Deviation High, Low, High/Low, Band, Process High, Low  
Set value High, Low
- b) Differential gap : 2 $^{\circ}$ C ( $^{\circ}$ F) or 2.0 $^{\circ}$ C ( $^{\circ}$ F) (Temperature input)  
0.2% (Voltage, current input)

#### Heater Break Alarm (For single phase)

- a) CT type : CTL-6-P-N(30A), CTL-12-S56-10L-N(100A)
- b) Display range : 0.0 to 100.0A
- c) Accuracy :  $\pm 5\%$  of input value or  $\pm 2A$  (whichever is larger)
- Output from Alarm 2 terminal.

#### Control Loop Break Alarm (LBA)

- a) LBA time setting : 0.1 to 200.0 min.
- b) LBA deadband : 0 to 9999  $^{\circ}$ C[ $^{\circ}$ F] or 100% of span (OFF by setting zero)
- Not available for heat/cool type.

#### Alarm Output

Relay output, Form A contact 250V AC 1A (resistive load)

### Communications

(Optional)

- a) Communication method : RS-485 (2-wire)
- b) Communication speed : 1200, 2400, 4800, 9600, 19200 BPS
- c) Bit format
- |              |                             |
|--------------|-----------------------------|
| Start bit :  | 1                           |
| Data bit :   | 7 or 8                      |
| Parity bit : | Even, odd or without parity |
| Stop bit :   | 1 or 2                      |
- d) Communication code : ASCII(JIS) 7-bit code
- e) Maximum connection : 31 (Address can be set from 0 to 99.)

### Waterproof/Dustproof

(Optional)

CB100 : IP66  
CB400/500/700/900 : IP65

- Waterproof/dustproof protection only effective from the front in panel mounted installations.
- Waterproof/dustproof protection is not available for close horizontal mounting installations.

### General Specifications

#### Supply Voltage

- a) 85 to 264V AC (Including supply voltage variation)  
[Rating : 100 to 240V AC] (50/60Hz common)
- b) 21.6 to 26.4V AC (Including supply voltage variation)  
[Rating : 24V AC] (50/60Hz common)
- c) 21.6 to 26.4V DC (Ripple rate 10% p-p or less) [Rating : 24V DC]

#### Power Consumption

Less than 10VA for standard AC type  
Less than 5VA for 24V AC type  
Less than 160mA for 24V DC type

#### Power Failure Effect

Not affected by power failure shorter than 20msec, otherwise reset to the initial state.

**Operating Environments** : 0 to 50 $^{\circ}$ C [32 to 122 $^{\circ}$ F] , 45 to 85% RH

**Memory Backup** : Backed up by non-volatile memory.

#### Net Weight

CB100 : Approx. 170g      CB700 : Approx. 290g  
CB400 : Approx. 250g      CB900 : Approx. 340g  
CB500 : Approx. 250g

#### External Dimensions (W x H x D)

CB100 : 48 x 48 x 100mm      CB700 : 72 x 72 x 100mm  
CB400 : 48 x 96 x 100mm      CB900 : 96 x 96 x 100mm  
CB500 : 96 x 48 x 100mm

### Compliance with Standards

- CE Mark
- UL Recognized
- CSA Certified



- Triac trigger output type and triac output are not CE Mark, UL Recognized or CSA Certified.

# Digital Temperature Controller CB Series

## Model and Suffix Code

Specifications	Model and Suffix Code	
Size	CB100 (1/16 DIN size) CB400 (1/8 DIN Vertical size) CB500 (1/8 DIN Horizontal size) CB700 (3/16 DIN size) CB900 (1/4 DIN size)	<input type="checkbox"/> <input type="checkbox"/> <input type="checkbox"/> - <input type="checkbox"/> <input type="checkbox"/> * <input type="checkbox"/> <input type="checkbox"/> - <input type="checkbox"/> <input type="checkbox"/> / <input type="checkbox"/> / Y
Control method	PID control with AT (reverse action) PID control with AT (direct action) Heat/Cool PID with AT (water cooling) Heat/Cool PID with AT (air cooling)	F D W A
Input type	See Range and Input Code Table	<input type="checkbox"/>
Range	See Range and Input Code Table	<input type="checkbox"/>
Control output (OUT1)	Relay output Voltage pulse DC current : 4 to 20mA Triac trigger Triac output	M V 8 T
Control output (OUT2)	Control method : F, D Relay output Voltage pulse DC current : 4 to 20mA Triac output	No symbol M V 8 T
Alarm 1	No alarm See Alarm Code Table <sup>2</sup>	N <input type="checkbox"/>
Alarm 2	No alarm See Alarm Code Table <sup>2</sup>	N <input type="checkbox"/>
Digital communications <sup>1</sup>	Not supplied RS-485 (2-wire system)	N 5
Waterproof/Dustproof	Not supplied Waterproof/Dustproof protection	N 1
Body color	Black White	A N
Instrument version	Version symbol	Y

<sup>1</sup> MODBUS protocol is also available. Specify "Z-1021" along with full model code. For additional information, contact RKC.  
<sup>2</sup> Order current transformers separately, part number in Accessory below.

### Range and Input Code Table

Thermocouple

Input	Code	Range	
K	K 01	0 - 200°C	
	K 02	0 - 400°C	
	K 03	0 - 600°C	
	K 04	0 - 800°C	
	K 05	0 - 1000°C	
	K 06	0 - 1200°C	
	K 07	0 - 1372°C	
	K 13	0 - 100°C	
	K 14	0 - 300°C	
	K 20	0 - 500°C	
	K A1	0 - 800°F	
	K A2	0 - 1600°F	
	K A3	0 - 2502°F	
	K A9	20 - 70°F	
	J	J 01	0 - 200°C
		J 02	0 - 400°C
		J 03	0 - 600°C
		J 04	0 - 800°C
		J 05	0 - 1000°C
J 06		0 - 1200°C	
J A1		0 - 800°F	
J A2		0 - 1600°F	
J A3		0 - 2192°F	
J A6		0 - 400°F	
R <sup>1</sup>	R 01	0 - 1600°C	
	R 02	0 - 1769°C	
	R 04	0 - 1350°C	
	R A1	0 - 3200°F	
	R A2	0 - 3216°F	
S <sup>1</sup>	S 01	0 - 1600°C	
	S 02	0 - 1769°C	
	S A1	0 - 3200°F	
B <sup>1</sup>	B 01	400 - 1800°C	
	B 02	0 - 1820°C	
	B A1	800 - 3200°F	
	B A2	0 - 3308°F	

<sup>1</sup> Type R, S and B input : Accuracy is not guaranteed between 0 to 399°C (0 to 799°F)  
<sup>2</sup> Type T and U input : Accuracy is not guaranteed between -199.9 to -100.0°C (-199.9 to -158.0°F)  
<sup>3</sup> DC current input : A 250 Ω resistor is externally connected at the input terminals.

### Alarm Code Table

Code	Type
A	Deviation High
B	Deviation Low
C	Deviation High/Low
D	Band Alarm
E	Deviation High with Alarm Hold
F	Deviation Low with Alarm Hold
G	Deviation High/Low with Alarm Hold
H	Process High

<sup>1</sup> Loop break alarm is not available for Heat/Cool PID control type.  
<sup>2</sup> Heater break alarm is allocated to Alarm 2. Heater break alarm is not available for current output.

Input	Code	Range
E	E 01	0 - 800°C
	E 02	0 - 1000°C
	E A1	0 - 1600°F
	E A2	0 - 1832°F
N	N 01	0 - 1200°C
	N 02	0 - 1300°C
	N A1	0 - 2300°F
	N A2	0 - 2372°F
T <sup>2</sup>	T 01	-199.9 - 400.0°C
	T 02	-199.9 - 100.0°C
	T 03	-100.0 - 200.0°C
	T 04	0.0 - 350.0°C
	T A1	-199.9 - 752.0°F
	T A2	-100.0 - 200.0°F
	T A3	-100.0 - 400.0°F
	T A4	0.0 - 450.0°F
	T A5	0.0 - 752.0°F
	W5Re W26Re	W 01
W 02		0 - 2320°C
PL II	W A1	0 - 4000°F
	A 01	0 - 1300°C
	A 02	0 - 1390°C
U <sup>2</sup>	A 03	0 - 1200°C
	A A1	0 - 2400°F
	A A2	0 - 2534°F
	U 01	-199.9 - 600.0°C
	U 02	-199.9 - 100.0°C
	U 03	0.0 - 400.0°C
	U A1	-199.9 - 999.9°F
	U A2	-100.0 - 200.0°F
	U A3	0.0 - 999.9°F
	L	L 01
L 02		0 - 800°C
L A1		0 - 800°F
L A2		0 - 1600°F

RTD

Input	Code	Range
Pt100	D 01	-199.9 - 649.0°C
	D 02	-199.9 - 200.0°C
	D 03	-100.0 - 50.0°C
	D 04	-100.0 - 100.0°C
	D 05	-100.0 - 200.0°C
	D 06	0.0 - 50.0°C
	D 07	0.0 - 100.0°C
	D 08	0.0 - 200.0°C
	D 09	0.0 - 300.0°C
	D 10	0.0 - 500.0°C
	D A1	-199.9 - 999.9°F
	D A2	-199.9 - 400.0°F
	D A3	-199.9 - 200.0°F
	D A4	-199.9 - 100.0°F
	D A5	-100.0 - 300.0°F
	D A6	0.0 - 100.0°F
	D A7	0.0 - 200.0°F
	D A8	0.0 - 400.0°F
	D A9	0.0 - 500.0°F
JPt100	P 01	-199.9 - 649.0°C
	P 02	-199.9 - 200.0°C
	P 03	-100.0 - 50.0°C
	P 04	-100.0 - 100.0°C
	P 05	-100.0 - 200.0°C
	P 06	0.0 - 50.0°C
	P 07	0.0 - 100.0°C
	P 08	0.0 - 200.0°C
	P 09	0.0 - 300.0°C
	P 10	0.0 - 500.0°C

Voltage and Current<sup>3</sup>

Input	Code	Range
0-5V DC	4 01	0.0 - 100.0
0-10V DC	5 01 <sup>1</sup>	0.0 - 100.0
1-5V DC	6 01	0.0 - 100.0
0-20mA DC	7 01	0.0 - 100.0
4-20mA DC	8 01	0.0 - 100.0

<sup>1</sup> Specify Z-1010 when ordering

### Supply Voltage

100 - 240V AC	24V AC	24V DC
---------------	--------	--------

### Accessory

Current transformer for heater break alarm

CTL-6P-N (0 - 30A)  
CTL-12-S56-10L-N (0 - 100A)

Shunt resistor for DC current input  
KD100-55

Terminal cover

KCA100-517 (CB100) KCA400-513 (CB400/500)  
KCA700-53 (CB700) KCA900-58 (CB900)



## External Dimensions

Units : mm

•External dimensions

### CB900

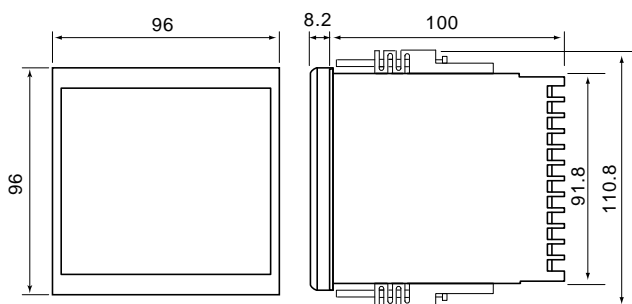

•Panel cutouts

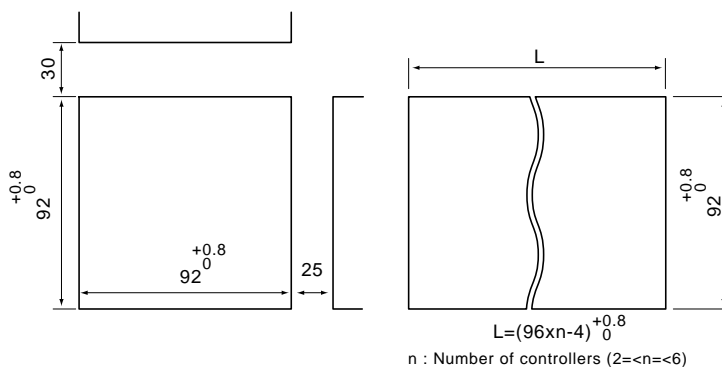

### CB700

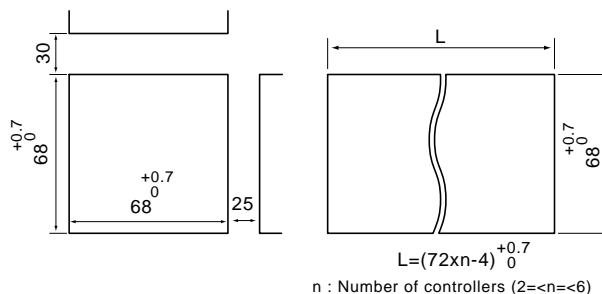
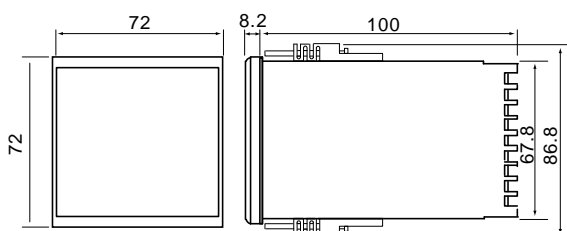

### CB500

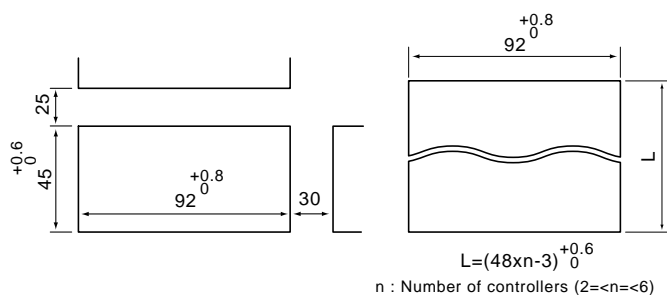
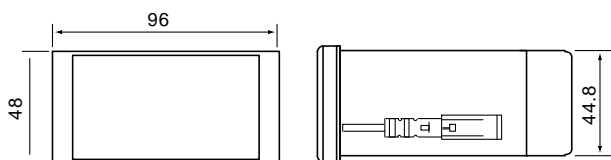

### CB400

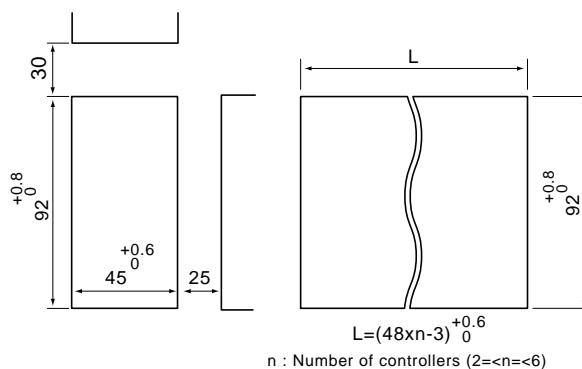
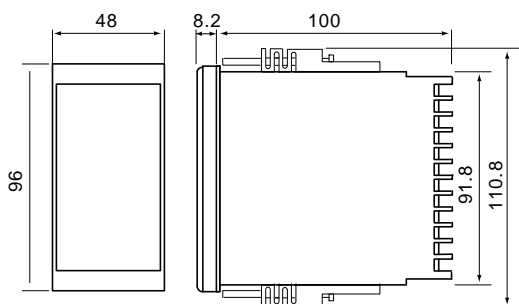

### CB100

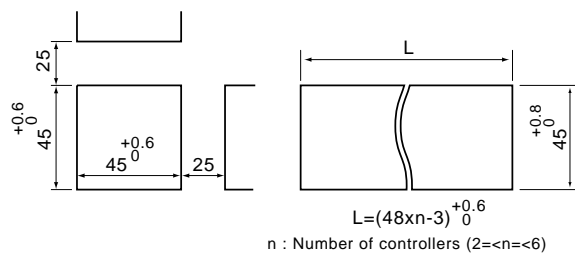
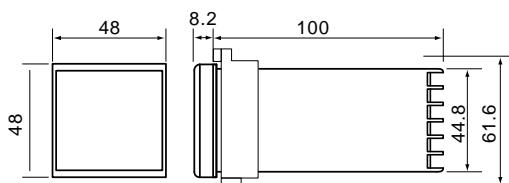

# Digital Temperature Controller CB Series

## Rear Terminals

CB400

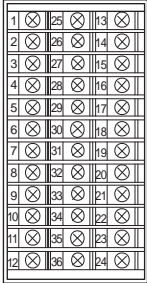

CB500



CB900

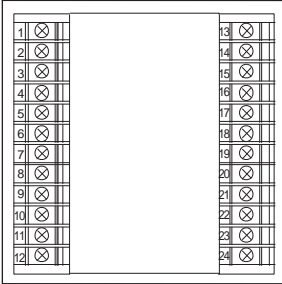

CB700

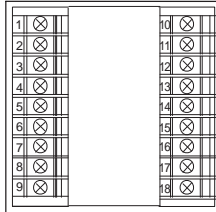

CB100

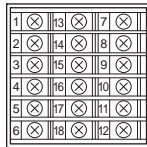

No.	Description
1	AC 100 to 240V
2	AC 24V
3	DC <sub>+</sub> 24V
4	DC <sub>-</sub> 24V
5	DC <sub>+</sub> 24V
6	DC <sub>-</sub> 24V
7	Alarm 2
8	Alarm 1
9	NO
10	NC
11	NO
12	NC

No.	Description
13	SG
14	T/R(A)
15	T/R(B)
16	
17	
18	
19	
20	
21	
22	
23	CT input for heater break alarm
24	CT

No.	Description
1	AC 100 to 240V
2	AC 24V
3	DC <sub>+</sub> 24V
4	DC <sub>-</sub> 24V
5	DC <sub>+</sub> 24V
6	DC <sub>-</sub> 24V
7	SG
8	T/R(A)
9	T/R(B)

No.	Description
10	Alarm 2
11	Alarm 1
12	
13	
14	CT input for heater break alarm
15	CT
16	Measured input (1) Thermocouple (2) RTD (3) Voltage/Current
17	
18	

No.	Description
1	AC 100 to 240V
2	AC 24V
3	DC <sub>+</sub> 24V
4	DC <sub>-</sub> 24V
5	DC <sub>+</sub> 24V
6	DC <sub>-</sub> 24V
7	Alarm 2
8	Alarm 1
9	NO
10	NC
11	NO
12	NC

No.	Description
13	SG
14	T/R(A)
15	T/R(B)
16	
17	CT input for heater break alarm
18	CT