



RB100 RB400 RB900



General Description

The RB Series is a high performance budget friendly process/temperature controller. Save space and save money with RB series that gives outstanding control capability and comprehensive functions incorporated into a slim body case.

Applications include various plastic machines (extruders, injection machine, etc), electric furnaces, semiconductor, food processing, environmental chambers and many others.

Features

- ☆ Easy-to-read with large 11-segment LCD display
- ☆ The depth of 60mm
- ☆ Sampling 0.25 sec
- ☆ Brilliant II PID control
- ☆ Start-up tuning and Autotuning

Panel space saving : 60mm depth

The RB Series has very short depth.
The series was designed with a mounting bracket that allows close horizontal mounting of as many as six units. .

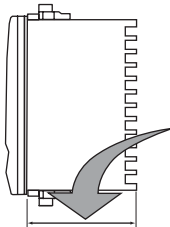

60mm
* RB100 : 63mm depth

Easy-to-read with large 11-segment LCD display

So bright and so large it is easy to read from a greater distance.

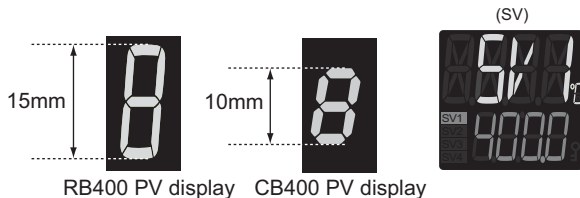

Numerous inputs and outputs

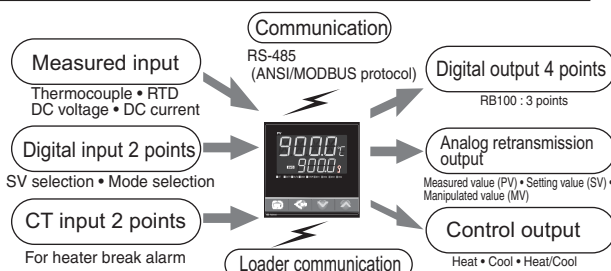

- The number of digital outputs is limited depending on the model and specifications.
- Analog Output is not available for some control types and models
- On the RB100, either communication or digital input can be selected.

Store up to 4 Set Values

Set value changeover is also possible by digital input.

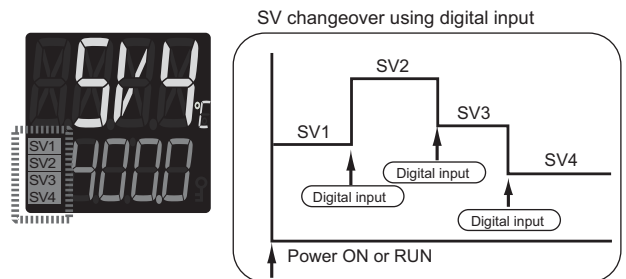

Timer Function

Control starts after the timer time elapses.

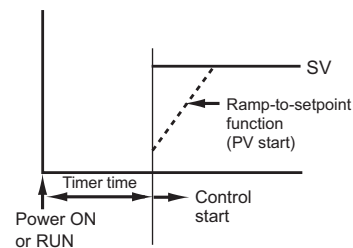

Control is performed during the timer time and stops after the timer time elapses.

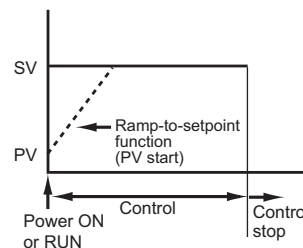

Features

Simple program control

Simple program control using a timer function / setting change proportion limiter

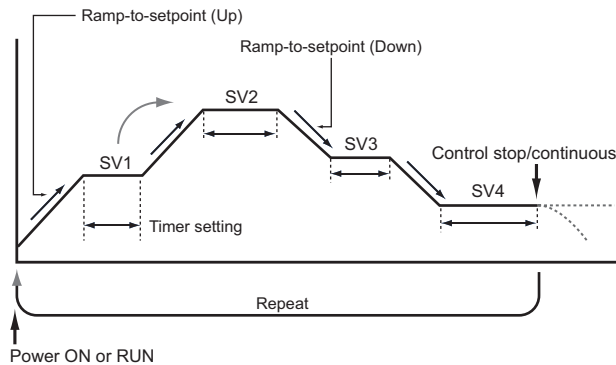

Calculates optimum PID values to stabilize control faster than ever

The improved autotuning algorithm calculates optimum PID values that shortens the time to reach stable control at the set value as well as eliminating overshoot/undershoot. The new PID algorithm also suppress overshoot/undershoot against external disturbance.

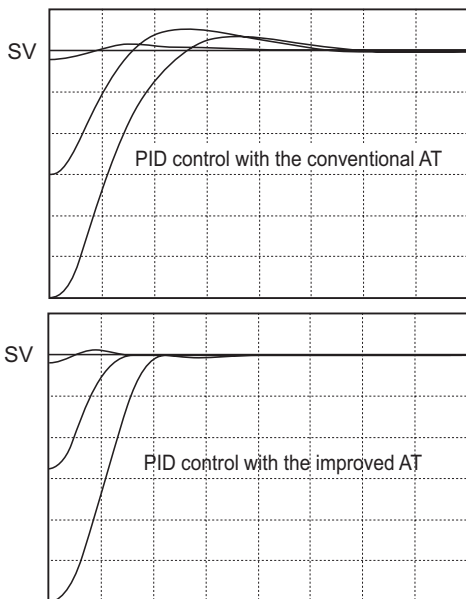

Easy Fine tuning with 6-level of control response adjustment

After the PID values have been autotuned, the Fine tuning (FT) function allows the operator to adjust the control response speed with a 6-level adjustment parameter (-3 to +3) without changing PID value.

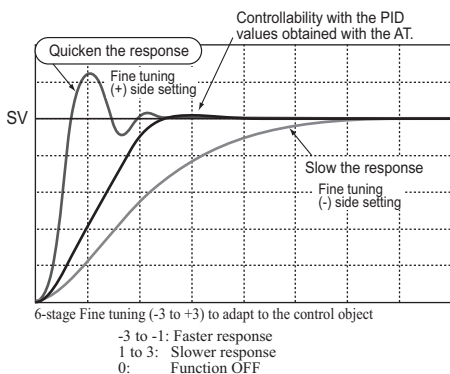

Startup tuning

Startup tuning eliminates time required for conventional autotuning as it calculates optimum PID values by temperature characteristics at start up. It is useful in applications which require a long time for conventional autotuning.

The timing of activation of start-up tuning can be selected from at power-up, at setpoint change, and at power-up/setpoint change. It is also settable to Only-once or always-ON.

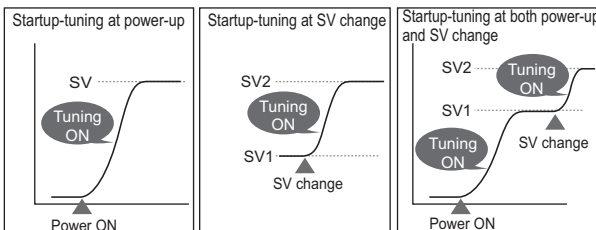

- Startup tuning function can be set ON/OFF.
- Heater power needs to be turned on simultaneously with or before turning on power to the temperature controller.
- If startup tuning does not calculate suitable PID values due to characteristics of application, use Autotuning function.

Easy parameter setup via USB loader port

The RB series has a standard loader port to connect to a PC USB port via COM-K (USB communication converter).

Using Win-UCI software on the PC, parameter settings can be easily saved on the PC in CSV format, and the same parameter settings are easily copied to other controllers.

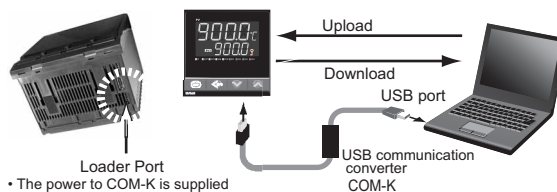

- The power to COM-K is supplied from the PC via the USB port so no power supply is necessary.
- The loader port is only for parameter setup.

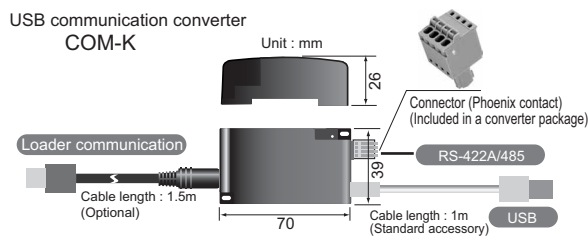

Model code :
COM-K-1 (With loader communication cable)
COM-K-N (Without loader communication cable)

PLC Communication Protocol Converter : COM-JE

A communication protocol converter becomes a Master Unit to PLC, and automatically stores temperature data into registers in a PLC. This enables easy handling of temperature control system to the existing PLC system is available.

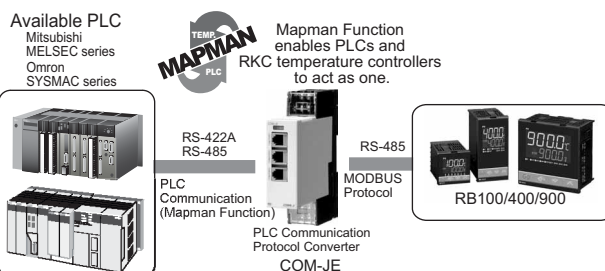



Specifications

Input

Input

- a) Temperature input group
 Thermocouple : K, J, R, S, B, E, T, N (JIS/IEC), PLII (NBS), W5Re/W26Re (ASTM)
 • Influence of external resistance : Approx. 0.25μV/Ω
 • Input break action : Up-scale / Down-scale (Selectable)
 RTD : Pt100 (JIS/IEC), JPt100 (JIS)
 • Influence of input lead resistance : Approx. 0.02[%/Ω] of reading
 • Maximum 10Ω per wire
 • Input break action : Up-scale
- b) Voltage • current input group
 Voltage : 0 to 1V DC, 0 to 5V DC, 1 to 5V DC, 0 to 10V DC
 • Input break action : Uncertain (indicates a value around 0V)
 Current : 4 to 20mA DC, 0 to 20mA DC
 • Inputs is selectable within each group.

Sampling Time

- 0.25 sec
 • 0.05sec or 0.25sec is available.

Input Digital Filter

0 to 100 sec (OFF when 0 is set.)

PV Bias

Temperature input : -1999(-199.9) to +9999(999.9)°C(°F)
 Voltage/Current input : -span to +span

Performance

Measuring Accuracy

- a) Thermocouple
 Type : K, J, T, E, N,
 Less than -100°C (-148°F) : ±(2.0°C[±3.6°F] + 1 digit)
 -100 to 500°C (-148 to 932°F) : ±(1.0°C [±1.8°F] + 1 digit)
 More than 500°C (932°F) : ±(0.2% of Reading + 1 digit)
 Type : N, S, R, PLII, W5Re/W26Re
 Less than 0°C (32°F) : ±(4.0°C[±7.2°F] + 1 digit)
 0 to 1000°C (-148 to 1832°F) : ±(2.0°C[±3.6°F] + 1 digit)
 More than 1000°C (1832°F) : ±(0.2% of Reading + 1 digit)
 Type : B
 Less than 400°C (752°F) : ±(7.0°C [±126°F] + 1 digit)
 400 to 1000°C (752 to 1832°F) : ±(2.0°C[±3.6°F] + 1 digit)
 More than 1000°C (1832°F) : ±(0.2% of Reading + 1 digit)
- b) RTD
 Less than 200°C (392°F) : ±(0.4°C [±0.7°F] + 1 digit)
 More than 200°C (392°F) : ±(0.2% of Reading + 1 digit)
- c) DC voltage and DC current
 ±(0.2% of span + 1 digit)
 • Close horizontal mounting error :
 ±2°C (3.6°F) [Less than -100°C (-146°F) input : ±3.5°C (6.3°F)]

Insulation Resistance

More than 20MΩ (500V DC) between measured terminals and ground
 More than 20MΩ (500V DC) between power terminals and ground

Dielectric Strength

1000V AC for one minute between measured terminals and ground
 1500V AC for one minute between power terminals and ground

Setting

SV limiter

Scaling low to scaling high (High/Low individual setting)

Ramp-to-setpoint

1(0.1) to span per Time
 (Time : 1 minute/1 hour (Selectable) Up/Down individual setting)

SV step function

Number of SV : 4 points (Default : 1 point)
 SV selecting method : Front key, Communication,
 Digital input (External contact input)

Timer function

Timer setting : 0 min 01 sec to 99 min 59 sec or
 0 hr 01 min to 99 hr 59 min (selectable)

Function

- Control starts after the timer time elapses.
- Control is performed during the timer time and stops after the timer time elapses.
- Link function from SV1 to SV4
 (After the timer time elapses, control is continued using SV4.)
- Link function from SV1 to SV4
 (After the timer time elapses, control is stopped.)
 Repeat : 0 to 9999 (Continuous when when 9999 is set.)

Control

Control Method

- a) PID control
 • P, PI, PD, ON/OFF control selectable
 • Direct action/Reverse action is selectable
 b) Heat/Cool type PID control

Autotuning Method

- a) For PID control (Direct action/Reverse action)
 b) For Heat/Cool PID control (For extruder, air cooling type)
 c) For Heat/Cool PID control (For extruder, water cooling type)
 d) For Heat/Cool PID control

Startup tuning

The condition to activate Startup Tuning is selectable among a) to g)

- a) At power-on and stop-to-run, one-time tuning
 b) At SV change, one-time tuning
 c) At power-on, stop-to-run and SV change, one-time tuning
 d) At every power-on and stop-to-run
 e) At every SV change
 f) At every power-on, stop-to-run and SV change
 g) Function off

Startup tuning

Setting range : -3 to +3 (6 levels, OFF when set to 0.)
 -3 to -1 : Faster response
 1 to 3 : Slower response
 OFF : Function OFF

Major Setting Range

Set value : Same as input range.
 Proportional band : 0(0.0) to input span (Temperature input)
 • When 0.1°C (°F) resolution, within 999.9°C (°F)
 0.0 to 1000.0% of span (Voltage, Current input)
 (ON/OFF control when P = 0)
 • Differential gap at ON/OFF control
 (High/Low individual setting) :
 Temperature input : 0(0.0) to 100 (100.0) (°C, °F)
 Voltage/Current input : 0.0 to 10.0% of span
 0 to 3600sec (P + D action when I = 0)
 Derivative time : 0 to 3600sec (P + I action when D = 0)
 Cool-side proportional band : 1 to 1000% of heat side proportional band
 Anti-Reset Windup(ARW) : 1 to 100% of heat side proportional band
 (Integral action is OFF when ARW = 0)
 Deadband/Overlap : -10 (-10.0) to 10 (10.0) °C (°F) (Temperature input)
 -10.0 to +10.0% of span (Voltage, Current input)
 • Minus setting : Overlap
 Derivative time action select : 0 : PV derivative, 1 : Deviation derivative
 Output limiter : -5.0 to +105.0% (PID control)
 (High/Low individual setting)
 0.0 to 105.0%Heat/Cool type PID control
 (Only limiter high)
 (Heat side/Cool side individual setting)
 Proportional cycle time : 0.1sec, 0.25sec, 0.5sec, 1 to 100 sec
 Manual output : Output limiter low to Output limiter high
 • Auto/Manual transfer action selection
 With bumpless/Without bumpless

Control output

Relay output : Form A contact, 250V AC 3A (resistive load)
 • Electric life : 1,000,000 cycles or more
 Voltage pulse output : 0/12V DC
 (Load resistance : more than 600Ω <less than 20mA>)
 • When out2 is no use, load resistance is more than
 300Ω <less than 10mA>.
 See page 7 "Maximum number of digital outputs (DO)
 by combinations of output (OUT1 and OUT2)
 Current output : 4 to 20mA DC, 0 to 20mA DC
 (Load resistance : less than 500Ω)
 SSR (Triac) output : Rated current : 0.5A
 (Ambient temperature : Less than 40°C)
 Voltage output : 0 to 5V DC, 1 to 5V DC, 0 to 10V DC
 (Load resistance : More than 1kΩ)
 (Output impedance : Less than 0.1Ω)
 Open collector output : Sink type
 Load current : Less than 100mA
 Load voltage : Less than 30V DC
 Minimum load current : 0.5mA
 ON voltage : Less than 2V
 (at maximum load current)
 Power OFF leakage current : Less than 0.1mA



Specifications

Event (Alarm) Output (Optional)

Number of Event

Up to 4 points (Event 1 to 4)
(RB100 : Up to 3 points, Heat/Cool type : Up to 2 points)

Event

Type : Deviation High, Low, High/Low*1, Band,
Process High, Low
Set value High, Low
Control Loop Break Alarm (LBA)
Heater break alarm (HBA),
Output of the communication monitoring result,
RUN status monitor
*1: Two types of alarm settings are field-selectable.
1. Independent high and low settings.
2. Common high/low setting
(Factory setting, unless specified in alarm code
when ordering)

Setting range

Deviation : - (Input span) to + (input span)
Differential gap : 0 to input span
Process, Set value : Same as input range
Differential gap : 0 to input span
MV value, FBR valued : -5.0 to +105.0%
Control loop break alarm (LBA)
: LBA time : 0 to 7200 sec. (OFF by setting zero)
LBA deadband : 0 to input span

Other Functions

- Hold/Re-hold action
 - Hold action is activated at power-on and stop-to-run.
Re-hold action is activated at power-on, stop-to-run, and the control set value change.
- Alarm output ON/OFF at stop mode is selectable.
- Energized/de-energized action is configurable.
- Differential gap : 0 (0.0) to span
- Delay timer : 0 to 600 sec
- Interlock (latch) function is configurable.

Heater Break Alarm

Number of CT Input : 2 points
CT Input type : CTL-6-P-N (30A), CTL-12-S56-10L-N (100A)
• Selectable
Accuracy : $\pm 5\%$ of input value + 1 digit) or 2A (whichever is larger)
Display range : 0.0 to 100.0A
Delay times : 0 to 255 times

Output

Relay contact output, Form a contact, 250V AC 1A (Resistive load)

Analog Retransmission Output (Optional)

Number of Outputs

1 point

Output types

Measured value (PV), Set value (SV), Manipulated output value (MV)

Output Signal

Current output : 4 to 20mA DC, 0 to 20mA DC
(Load resistance : Less than 600 Ω)
Continuous voltage output : 0 to 1V DC, 0 to 5V DC, 1 to 5V DC, 0 to 10V DC
(Load resistance : More than 1k Ω)

Output Resolution

Approx. more than 1/2000

Digital Input (Optional)

Number of Sub Output

2 points (DI1, DI2)

Input method

Non-voltage contact output

Function

- SV selection, STOP/RUN, Auto/Manual, Alarm interlock reset,
 - Selectable

Communications (Optional)

Communication method : RS-485

Communication speed : 2400, 4800, 9600, 19200, BPS

Protocol : ANSI X3.28(1976) 2.5 A4
MODBUS-RTU

Bit format

Start bit : 1
Data bit : 7 or 8 •For MODBUS 8 bit only
Parity bit : Without, Odd or Even
Stop bit : 1 or 2

Maximum connection : 31 units

Terminating resistor : External installation is necessary (120 Ω 1/2W)

Buffer mode : Correspond
(Mode in which writing to EEPROM is not performed for setting changes)

Waterproof/Dustproof (Standard)

NEMA4X, IP66

- Waterproof/Dustproof protection only effective from the front in panel mounted installation.

General Specifications

Supply Voltage

- 90 to 264V AC (Including supply voltage variation)
[Rating : 100 to 240V AC] (50/60Hz selectable)
- 21.6 to 26.4V AC (Including supply voltage variation)
[Rating : 24V AC] (50/60Hz selectable)
- 21.6 to 26.4V DC (Ripple rate 10% p-p or less) [Rating:24VDC]

Power Consumption

- RB100 : Less than 8.5VA for AC type (at 240V AC)
Less than 4.7VA for 24V AC type
Less than 108mA for 24V DC type
- RB400 : Less than 8.7VA for AC type (at 240V AC)
Less than 5.8VA for 24V AC type
Less than 141mA for 24V DC type
- RB900 : Less than 9.0VA for AC type (at 240V AC)
Less than 6.0VA for 24V AC type
Less than 141mA for 24V DC type

Power Failure Effect

- A power failure of 20m sec or less will not affect the control action.
- RB100, 24V AC/DC type : 10msec or less

Operating Environments : 0 to 50°C [32 to 122°F]

10 to 90% RH (Non condensing)
Absolute humidity : MAX. W.C 29.3g/m³ dry
air at 101.3kPa.

Memory Backup : Backed up by non-volatile memory
• Data retaining period : Approx. 10 years
• Number of writing : Approx. 1,000,000 times.
(Depending on storage and operating conditions.)

Net Weight

RB100 : Approx. 120g
RB400 : Approx. 185g
RB900 : Approx. 250g

External Dimensions (W x H x D)

RB100 : 48 x 48 x 60mm
RB400 : 48 x 96 x 60mm
RB900 : 96 x 96 x 63mm

Process/Temperature Controller RB100/400/900

Model and Suffix Code

Specifications		Model and Suffix Code											
		①	②	③	④	⑤	⑥	⑦	⑧	⑨	⑩	⑪	⑫
RB100 (48 X 48mm, 1/16 DIN) RB400 (48 X 96mm, 1/8 DIN) RB900 (96 X 96mm, 1/4 DIN)													
① Control Method	PID control with AT (Reverse action) PID control with AT (Direct action) Heat/Cool PID control with AT Heat/Cool PID control with AT for extruder (Air cooling type) Heat/Cool PID control with AT for extruder (Water cooling type)	F D G A W											
② Input and range	See Input range Code Table												
③ Output 1 (OUT1)	See Output 1 Code Table (Control output)												
④ Output 2 (OUT2) ^{*1, *2}	Not supplied See Output 2 Code Table (Control output or analog retransmission output (AO))												
⑤ Power Supply	24V AC/DC 100 to 240V AC												
⑥ Digital output (DO) ^{*3}	Not supplied DO 1 points (DO1) DO 2 points (DO1, DO2) DO 4 points (DO1 to DO4) • Available for RB400/900 only												
⑦ CT input	Not supplied For CTL-6-P-N (0 to 30A) 1 point • When digital output code is "N", cannot be specified. For CTL-12-S56-10L-N (0 to 100A) 1 point • When digital output code is "N", cannot be specified. For CTL-6-P-N (0 to 30A) 2 point • When digital output code is "N", cannot be specified. For CTL-12-S56-10L-N (0 to 100A) 2 point • When digital output code is "N", cannot be specified.												
⑧ Communication/ Digital input (DI)	Not supplied RS-485 (ANSI/RKC standard protocol) RS-485 (MODBUS protocol) DI 2 points RS-485 (ANSI/RKC standard protocol) + DI 2 points • Available for RB400/900 only RS-485 (MODBUS protocol) + DI 2 points • Available for RB400/900 only												
⑨ Waterproof/ Dustproof	Not supplied Waterproof/Dustproof protection												
⑩ Case color	White case Black case												
⑪ Quick start code	No quick start code (Default setting) Specify quick start code (DO type)												
⑫ Instrument version	Version symbol												

*1 When control method is selected for PID control (Code : F, D), output 2 is available for analog retransmission output.

*2 On the RB100, the event 3 output function can be specified for output 2.

*3 The number of DO points is limited in some combinations of OUT1 and OUT2 (control output) types.

Input range code table

Temperature Input Group (Field-programmable)				RTD				DC Current • Voltage Group (Field-programmable)				
Thermocouple				Pt100 (JIS/IEC)				JPt100 (JIS)				
Input	Code	Range	Input	Code	Range	Input	Code	Range	Input	Code	Range	
K (JIS/IEC)	K'01	0 to 200°C	S (JIS/IEC)	S'02	0 to 1769°F	Pt100 (JIS/IEC)	D'01	-199.9 to +649.0°C	DC Current • Voltage Group (Field-programmable)	0 to 1V DC	3'01	-1999 to +9999 (Programmable)
	K'02	0 to 400°C		S'A2	0 to 3216°F		D'02	-199.9 to +200.0°C		0 to 5V DC	4'01	
	K'03	0 to 600°C		B (JIS/IEC)	B'01		400 to 1800°C	D'03		-100.0 to +50.0°C	1 to 10V DC	5'01
	K'04	0 to 800°C			B'02		0 to 1820°C	D'04		-100.0 to +100.0°C	1 to 5V DC	6'01
	K'05	0 to 1000°C		E (JIS/IEC)	E'01		0 to 800°C	D'05		-100.0 to +200.0°C	0 to 20mA DC	7'01
	K'06	0 to 1200°C			E'02		0 to 1000°C	D'06		0.0 to 50.0°C	4 to 20mA DC	8'01
	K'41	-200 to +1372°C	N (JIS/IEC)	N'01	0 to 1200°C		D'07	0.0 to 100.0°C		Factory set value : 0.0 to 100.0		
	K'09	0.0 to 400.0°C		N'02	0 to 1300°C		D'08	0.0 to 200.0°C		• For current input, connect is a 250Ω shunt resistor to the input terminals. Model code : KD100-55		
	K'10	0.0 to 800.0°C	T (JIS/IEC)	T'02	-199.9 to +100.0°C		D'09	0.0 to 300.0°C				
	K'43	-199.9 to +400.0°C		T'03	-100.0 to +200.0°C		D'10	0.0 to 500.0°C				
	K'A1	0 to 800°F	W5Re/W26Re (ASTM)	W'01	0 to 2000°C	D'A1	-199.9 to +400.0°F					
	K'A2	0 to 1600°F		W'02	0 to 2320°C	D'A2	-199.9 to +200.0°F					
	K'C7	-328 to +2501°F	PLII (NBS)	A'01	0 to 1300°C	D'A3	-199.9 to +200.0°F					
	K'C8	-100.0 to +752.0°F		A'02	0 to 1390°C	D'A4	-199.9 to +100.0°F					
	J (JIS/IEC)	J'01	0 to 200°C	A'01	0 to 1300°C	D'A5	-199.9 to +300.0°F					
		J'02	0 to 400°C		A'02	0 to 1390°C	D'A6	0.0 to 100.0°F				
J'03		0 to 600°C	A'A1	0 to 2400°F	D'A7	0.0 to 200.0°F						
J'04		0 to 800°C		A'A2	0 to 2534°F	D'A8	0.0 to 400.0°F					
J'05		0 to 1000°C	P	P'01	-199.9 to +649.0°C	D'A9	0.0 to 500.0°F					
J'06		0 to 1200°C		P'02	-199.9 to +200.0°C	D'B2	-199.9 to +900.0°F					
J'15		-200 to +1200°C	R (JIS/IEC)	R'02	0 to 1769°F	P'03	-100.0 to +50.0°C					
J'07		-199.9 to +300.0°C		R'A2	0 to 3216°F	P'04	-100.0 to +100.0°C					
J'A1	0 to 800°F			P'05	-100.0 to +200.0°C							
J'A2	0 to 1600°F			P'06	0.0 to 50.0°C							
J'B9	-328 to +2192°F			P'07	0.0 to 100.0°C							
J'C8	-199.9 to +550.0°F			P'08	0.0 to 200.0°C							

*1 : Accuracy is not guaranteed for less than -100°C (-146°F).

*2 : Accuracy is not guaranteed for less than 400°C (752°F) for Input Type R, S, B, and W5Re/W26Re.

Output signal code table

Output 1 Code Table		Output 2 Code Table		Output Type		Code	Remarks
Relay contact output	M	Relay contact output (Cool side output)	M	Relay contact output (Event 3 [DO3] output)	P		Only RB100
Voltage pulse output	V	Voltage pulse output (Cool side output)	V	0 to 20mA DC (Analog retransmission output [AO])	R		Only PID control
0 to 5V DC	4	0 to 5V DC (Cool side output)	4	4 to 20mA DC (Analog retransmission output [AO])	S		Only PID control
0 to 10V DC	5	0 to 10V DC (Cool side output)	5	0 to 5V DC (Analog retransmission output [AO])	X		Only PID control
1 to 5V DC	6	1 to 5V DC (Cool side output)	6	0 to 10V DC (Analog retransmission output [AO])	Y		Only PID control
0 to 20mA DC	7	0 to 20mA DC (Cool side output)	7	1 to 5V DC (Analog retransmission output [AO])	Z		Only PID control
4 to 20mA DC	8	4 to 20mA DC (Cool side output)	8				
Triac output	T	Triac output (Cool side output)	T				
Open collector output	D	Open collector output (Cool side output)	D				

Maximum number of digital outputs (DO) by combinations of output (OUT1 and OUT2)

Process/Temperature Controller RB 100/400/900

● Maximum number of digital outputs (DO) by combinations of output (OUT1 and OUT2)

		OUT2 (Including transmission output)					
		No OUT2 output	M, T, D	V (10 mA)	V (20 mA)	Current output	Voltage output
OUT1	M, T, D	4	4	4	4	4	4
	V (Load: 10 mA)	4	4	4	4	2	2
	V (Load: 20 mA)	4	4	4	2	2	2
	Current output	4	4	2	2	2	2
	Voltage output	4	4	2	2	2	2

() : Represents selection of digital outputs
-DO3 and DO4 are not available.)

*1 When the instrument has two digital outputs (DO1 and DO2) and no OUT2 output, "V" type output (load: 40mA) can be specified for OUT1.

Quick Start Code

- Quick start code 2 tells the factory to ship with each parameter preset to the values detailed as specified by the customer. Quick start code is not necessarily specified when ordering, unless the preset is requested. These parameters are software selectable items and can be re-programmed in the field via the manual.

● Event Code Table (Programmable)

Specifications	Quick start code	<input type="checkbox"/>	<input type="checkbox"/>	<input type="checkbox"/>	<input type="checkbox"/>	<input type="checkbox"/>
Digital output 1 (DO1) (Event 1 type)	None See event code table	N				
Digital output 2 (DO2) (Event 2 type)	None See event code table		N			
Digital output 3 (DO3) (Event 3 type) *1	None See event code table			N		
Digital output 4 (DO4) (Event 4 type) *2	None See event code table				N	
Digital input (DI)	None SV1 to SV4 select SV1/SV2 select + STOP/RUN SV1 to SV2 select + MANUAL/AUTO SV1 to SV2 select + Alarm interlock reset STOP/RUN + MANUAL/AUTO STOP/RUN + Alarm interlock reset MANUAL/AUTO + Alarm interlock reset					N 1 2 3 4 5 6 7

*1: On the RB100, this can be specified when event 3 (Code : "P") is selected in output 2.

*2: On the RB100, this is fixed at "none".

Code	Event Type
A	Deviation High
B	Deviation Low
C	Deviation High/Low (Common high/low setting)
D	Band (Common high/low setting)
E	Deviation High with Hold
F	Deviation Low with Hold
G	Deviation High/Low with Hold (Common high/low setting)
H	Process High
J	Process Low
K	Process High with Hold
L	Process Low with Hold
Q	Deviation High with Alarm Re-hold
R	Deviation Low with Alarm Re-hold
T	Deviation High/Low with Re-Hold (Common high/low setting)
U	Band (Individual high and low settings)
V	Set value High
W	Set value Low
X	Deviation High/Low (Individual high and low settings)
Y	Deviation High/Low with Alarm Hold (Individual high and low settings)
Z	Deviation High/Low with Alarm Re-Hold (Individual high and low settings)
1	Heater break alarm (HBA)
2	Loop break alarm
3	FAIL
4	RUN status
5	Output of the communication monitoring result

Example of Model Code and Quick start code

Specifications
 Input : Thermocouple K 0.0 to 400.0°C
 Control : PID control for Heating, (Output : 4 to 20mA DC)
 Digital output (Alarm) : 2 point (Deviation High, Deviation Low)
 Analog retransmission output : 0 to 10V DC
 Digital input : 2 point (STOP/RUN, MANUAL/AUTO)

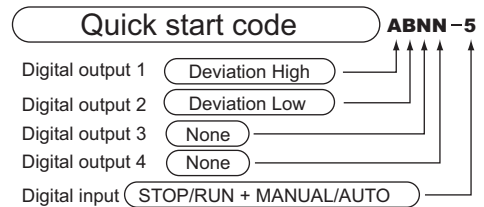
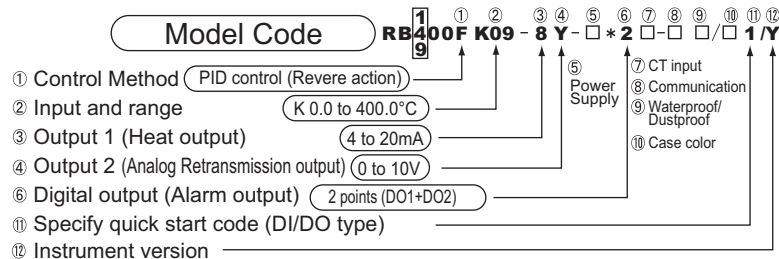

Process/Temperature Controller RB100/400/900



External Dimensions

Unit : mm

RB100

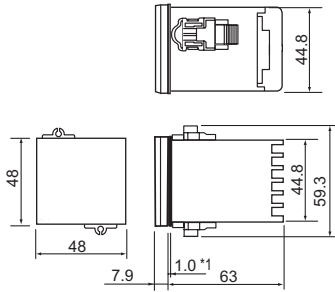

*1 : Case rubber packing (optional) [Waterproof/dustproof]

Panel Cutout

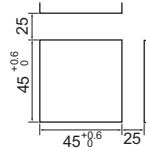

(Panel thickness must be between 1 to 10mm)

(Close horizontal mounting)
* Up to 6 units

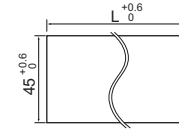

$L = (48 \times n - 3)$
n : Number of controllers
($2 \leq n \leq 6$)

• Waterproof/dustproof is not available for close horizontal mounting.

RB400

The mounting brackets can be attached on the sides of the controller. However, to make the controller waterproof and dustproof, attach the mounting brackets to the top and bottom. (2 places).

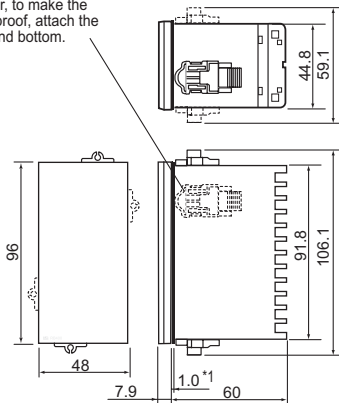

*1 : Case rubber packing (optional) [Waterproof/dustproof]

Panel Cutout

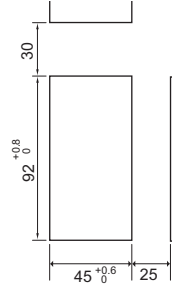

(Panel thickness must be between 1 to 10mm)

(Close horizontal mounting)
* Up to 6 units

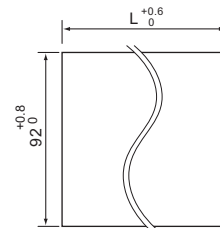

$L = (48 \times n - 3)$
n : Number of controllers
($2 \leq n \leq 6$)

• Waterproof/dustproof is not available for close horizontal mounting.

RB900

The mounting brackets can be attached on the sides of the controller. However, to make the controller waterproof and dustproof, attach the mounting brackets to the top and bottom. (4 places).

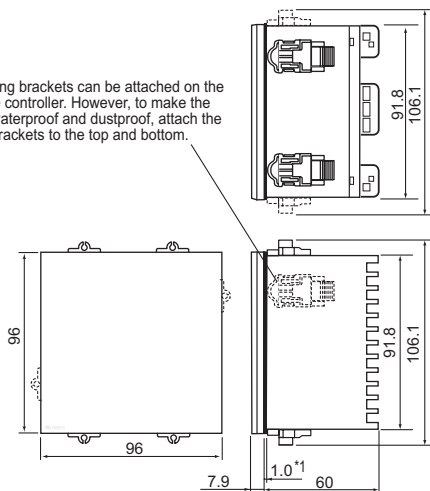

*1 : Case rubber packing (optional) [Waterproof/dustproof]

Panel Cutout

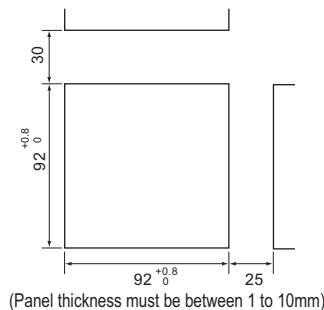

(Panel thickness must be between 1 to 10mm)

(Close horizontal mounting)
* Up to 6 units

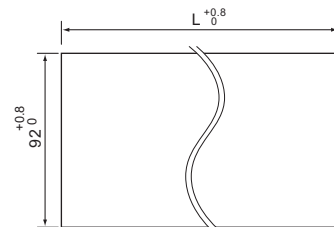

$L = (96 \times n - 4)$
n : Number of controllers
($2 \leq n \leq 6$)

• Waterproof/dustproof is not available for close horizontal mounting.

Process/Temperature Controller RB 100/400/900

Rear Terminals

RB100

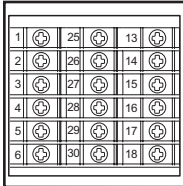

• Use a solderless terminal for screw size M3, width 5.8mm or less.

No	Contents
1	L
2	N
3	+
4	-
5	+
6	-
3	(1) NO (2) Triac (3) (4) (OUT2) or (AO)
4	(1) NO (2) Triac (3) (4) (OUT1)

Power supply
100 to 240V 24V AC 24V DC

Control output 1, 2 (OUT1,2) or Analog retransmission output, Digital output (AO)
(1) Relay contact output
(2) Voltage pulse / Current/Voltage
(3) SSR (Triac)
(4) Open collector

No	Contents
13	SG
14	T/R(A)
15	T/R(B)
16	CT2
17	CT1
18	

Communication RS-485
(*) (2) (DI 2)
(1) (DI 1)
COM

Digital input (DI 1, 2) (*)

CT1,CT2 input (*)

(*) Optional

No	Contents
7	DO2
8	DO1
9	COM
10	A B
11	(1) (2) (3)
12	

Digital output 1, 2 (DO1,2) (*)
Relay contact output

Measuring input (*)
(1) Thermocouple
(2) RTD
(3) Voltage/Current

RB400

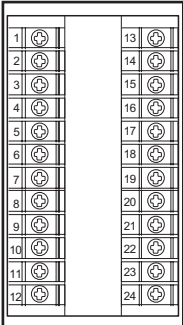

• Use a solderless terminal for screw size M3, width 5.8mm or less.

RB900

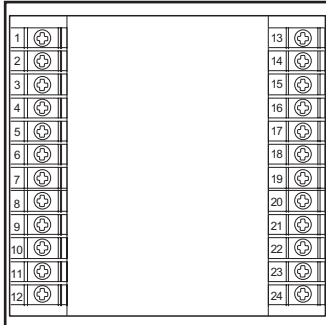

No	Contents
1	L
2	N
3	+
4	-
5	+
6	-
3	(1) NO (2) Triac (3) (4) (OUT2) or (AO)
4	(1) NO (2) Triac (3) (4) (OUT1)

Power supply
100 to 240V 24V AC 24V DC

Control output 1, 2 (OUT1,2) or Analog retransmission output (AO)
(1) Relay contact output
(2) Voltage pulse / Current/Voltage
(3) SSR (Triac)
(4) Open collector

Digital output 1, 2 (DO1,2) (*)
Relay contact output

Measuring input (*)
(1) Thermocouple
(2) RTD
(3) Voltage/Current

No	Contents
13	SG
14	T/R(A)
15	T/R(B)
16	(2) (DI 2)
17	(1) (DI 1)
18	COM
19	DO4
20	DO3
21	COM
22	
23	CT2
24	CT1

Communication RS-485 (*)

Digital input (DI 1, 2) (*)

Digital output 3, 4 (DO3,4) (*)
Relay contact output

CT1,CT2 input (*)

Accessory

Current transformer for heater break alarm (HBA)

Model code
CTL-6-P-N (0 to 30A)
CTL-12-S56-10L-N (0 to 100A)

CTL-6-P-N (Unit : mm)

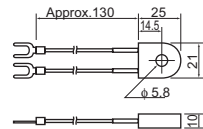

CTL-12-S56-10L-N

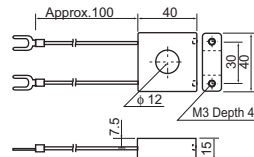

Terminal Cover

RB900

RB400

RB100

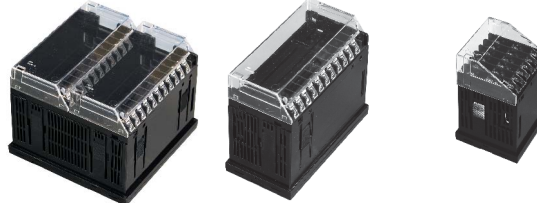

Model Code :
KFB400-58
(RB900 uses 2 unit)

Model Code :
KCA100-517

250Ω shunt resistor for current input

Model code
KD100-55

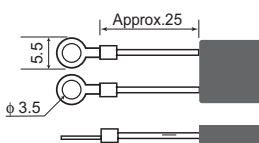

Front Cover

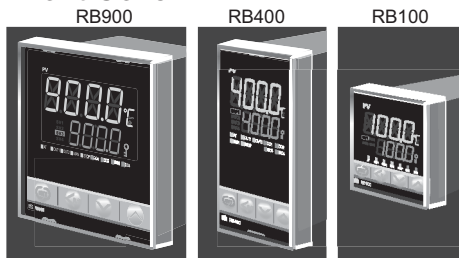

Model Code :
KRB900-36

Model Code :
KRB400-36

Model Code :
KRB100-36A