



MA901



General Description

The MA901 controls up to 8 channels in a compact 1/4 DIN size. The MA901 increases zone density and makes smaller numbers of loops affordable, yet still holds many of the advantages that a single loop controller might offer. This unit will aid designers of control equipment saving labor costs, installation costs, electric panel sizes, and operation costs.

Features

- ☆ 8 channels of control
- ☆ Multi-memory area
- ☆ Digital communications
- ☆ Digital contact input
- ☆ Multiple alarm functions
- ☆ Close horizontal mounting
- ☆ IP65 Waterproof/Dustproof protection

8 channels Control

8 channels of temperature controls are packed into 96 x 96 x 100mm case. The MA901 can reduce your panel cutouts and make your panel board smaller.

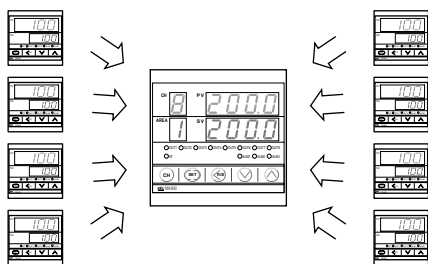

Multi-Memory Area

Up to 8 kinds of combinations of temperature set value, PID constant, alarm set value etc for each channel can be registered as "memory area" (recipe).

The change of settings caused by the change of a process and product can be simply realized only by switching the "area". The switching of the area by optional external contact input is also available.

The available parameters for multi memory area :
 SV, Alarm set values, PID constants, Anti-reset windup, Overlap/dead band, Setting change rate limiter, Channel used/unused

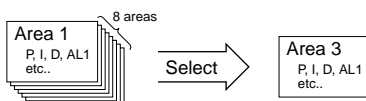

Digital Communications (Optional)

An optional communications interface, RS-232C or RS-422A, RS-485 is available for networking to computers, PLCs and SCADA software. MODBUS or ANSI (RKC standard) protocol can be selected. Up to 31 units can be interfaced on one RS-422A or RS-485 communication line.

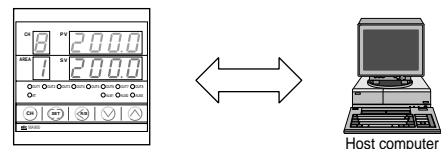

Digital Contact Input (Optional)

An optional digital contact input is available for RUN/STOP and memory area switching. (RUN/STOP switching can also be completed at the front key panel.)

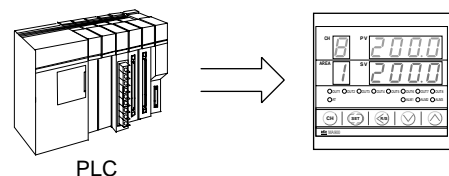

Multiple Alarm Functions

The MA901 provides a wide selection of alarm types to configure up to three alarms.

- Alarm 1 (Standard) :
Temperature alarms, Loop break alarm, FAIL
- Alarm 2 (Optional) :
Temperature alarms, Heater break alarm, FAIL
- Alarm 3 (Optional) :
Temperature alarms, FAIL

• Alarm output is common to all channels.

Multi-Loop Digital Temperature Controller MA901



Specifications

Input

Number of Inputs
8 points

Input

- a) Thermocouple : K, J, R, S, B, E, T, N (JIS/IEC), PLII (NBS)
W5Re/W26Re (ASTM), U, L (DIN)
- Influence of external resistance : Approx. $0.2\mu\text{V}/\Omega$
 - Input break action : Up-scale
- b) RTD : Pt100 (JIS/IEC), JPt100 (JIS)
- Influence of input lead resistance : Approx. $0.01[\%/\Omega]$ of reading
 - Maximum 10Ω per wire
 - Input break action : Up-scale
 - Input is not isolated.
- c) DC voltage : 0 to 5V, 1 to 5V, 0 to 10V
- Input break action : Down-scale
 - Input is not isolated.

Sampling Time
1 sec

Input Filter

First order lag digital filter
Time constant 1 to 100 sec. (OFF when 0 is set)

PV Bias

- span to +span (Within -1999 to 9999)

Performance

Measuring Accuracy

- a) Thermocouple
 $\pm(0.3\%$ of reading + 1 digit) or $\pm 2^\circ\text{C}$ (4°F) whichever is larger
- Accuracy is not guaranteed between 0 and 399°C (0 and 799°F) for type R, S and B.
 - Accuracy is not guaranteed less than -100.0°C (-158.0°F) for type K, J, T and U.
- b) RTD
 $\pm(0.3\%$ of reading + 1 digit) or $\pm 0.8^\circ\text{C}$ (1.6°F) whichever is larger
- c) DC voltage
 $\pm(0.3\%$ of span + 1 digit)

Insulation Resistance

More than $20\text{M}\Omega$ (500V DC) between measured terminals and ground
More than $20\text{M}\Omega$ (500V DC) between power terminals and ground

Dielectric Strength

1000V AC for one minute between measured terminals and ground
1500V AC for one minute between power terminals and ground

Control

Control Method

PID control (with autotuning function)

- Available for reverse and direct action. (Specify when ordering.)

Major Setting Range

Set value : Same as input range.
Proportional band : 1 to span (ON/OFF action when P=0)

- Differential gap at ON/OFF action is 2°C ($^\circ\text{F}$) or 0.2%.

Integral time : 1 to 3600sec.(P + D action when I=0)
Derivative time : 1 to 3600sec.(P + I action when D=0)
Anti-Reset Windup(ARW) : 1 to 100% of heat side proportional band
(Integral action is OFF when ARW=0)
Proportional cycle time : 1 to 100 sec.

Operation Mode

Available for switching each channel to be normal (control), alarm monitoring (control output OFF, alarm action enabled) and unused.

Control Output

Relay output : Form A contact, 250V AC 3A (resistive load)
Voltage pulse output : 0/12V DC
(Load resistance : More than 600Ω)
Current output : 4 to 20mA DC or 0 to 20mA DC
(Load resistance : Less than 600Ω)
Triac output : Rating : 0.5A
(An ambient temperature is less than 40°C)

- Measurement terminals and output terminals are not isolated.

Alarm (Up to 3 points)

(Optional)

- Alarm 1 output (Standard), Alarm 2, 3 (Optional)

Temperature Alarm

- a) Type : Deviation High, Low, High/Low, Band,
Process High, Low
Set value High, Low, Fail
- b) Differential gap : 2°C ($^\circ\text{F}$) or 2.0°C ($^\circ\text{F}$) (Temperature input)
 0.2% (Voltage, current input)

Control Loop Break Alarm (LBA)

- a) LBA time setting : 0.1 to 200.0 min.
b) LBA deadband : 0 to 9999°C [$^\circ\text{F}$] or 100% of span
(OFF by setting zero)
- Output from Alarm 1 terminal.

Heater Break Alarm (For single phase)

- a) CT type : CTL-6-P-N (30A), CTL-12-S56-10L-N (100A)
b) Display range : 0.0 to 100.0A
c) Accuracy : $\pm 5\%$ of input value or $\pm 2\text{A}$ (whichever is larger)
- Output from Alarm 2 terminal.

Alarm Output

- a) Alarm Output 1 to 3
Relay output, Form A contact 250V AC 1A (resistive load)

Contact Input

(Optional)

Number of Inputs : 5 points

Contact Input Type

- a) RUN/STOP switching (OPEN : STOP, CLOSE : RUN)
b) Memory area selection :
Area selection : 3 points (BCD input 0 to 7)
Data set : 1 point

Input Rating

Non-voltage contact input (OPEN : $500\text{k}\Omega$ or more, CLOSE : 10Ω or less)

Communications

(Optional)

- a) Communication method : RS-232C (3-wire), RS-422A (4-wire)
RS-485 (2-wire)
- b) Communication speed : 2400, 4800, 9600, 19200 BPS
- c) Bit format
Start bit : 1
Data bit : 7 or 8 •For MODBUS 8 bit only
Parity bit : Even, odd or without parity
Stop bit : 1 or 2
- d) Communication code : ASCII(JIS) 7-bit code
- e) Maximum connection : RS-232C : 1 unit
RS-422A, RS-485 : 31 units
(Address can be set from 0 to 99.)

Waterproof/Dustproof

(Optional)

IP65

- Waterproof/dustproof protection only effective from the front in panel mounted installations.

General Specifications

Supply Voltage

- a) 90 to 264V AC (Including supply voltage variation)
[Rating : 100 to 240V AC] (50/60Hz common)
- b) 21.6 to 26.4V AC(Including supply voltage variation)
[Rating : 24V AC] (50/60Hz common)
- c) 21.6 to 26.4V DC(Ripple rate 10% p-p or less) [Rating : 24V DC]

Power Consumption

Less than 14VA for standard AC type at 100V
Less than 20VA for standard AC type at 240V
Less than 11VA for 24V AC type
Less than 330mA for 24V DC type

Power Failure Effect

Not affected by power failure shorter than 30msec, otherwise reset to the initial state.

Operating Environments

0 to 50°C [32 to 122°F] , 45 to 85% RH

Memory Backup

Backed up by non-volatile memory.
Number of writing : Approx. 100,000 times
Data retaining period : Approx. 10 years

Net Weight

Approx. 560g

External Dimensions (W x H x D)

96 x 96 x 100mm

Compliance with Standards

- CE Mark
- UL Recognized
- CSA Certified
- C-Tick Mark



Multi-Loop Digital Temperature Controller MA901

Model and Suffix Code

Specifications	Model and Suffix Code										
Model	MA901-8	<input type="checkbox"/>	<input type="checkbox"/>	<input type="checkbox"/>	<input type="checkbox"/>	<input type="checkbox"/>	<input type="checkbox"/>	<input type="checkbox"/>	<input type="checkbox"/>	<input type="checkbox"/>	<input type="checkbox"/>
Control method	PID control with AT (reverse action) PID control with AT (direct action)	F									
Input type	See Range and Input Code Table	<input type="checkbox"/>									
Range	See Range and Input Code Table	<input type="checkbox"/>									
Control output (CH 1 to 4)	Relay output Voltage pulse DC current : 0 to 20mA DC current : 4 to 20mA Triac output	M	V	7	8	T					
Control output (CH 5 to 8)	Relay output Voltage pulse DC current : 0 to 20mA DC current : 4 to 20mA Triac output	M	V	7	8	T					
Power supply voltage	24V AC/DC 100 to 240V AC	3	4								
Alarm 1 ¹	See Alarm 1 Code Table (Standard)	<input type="checkbox"/>									
Alarm 2 ^{1, 2, 3}	No alarm Heater break alarm (CTL-6-P-N) Heater break alarm (CTL-12-S56-10L-N) See Alarm 2 and 3 Code Table							N	P	S	
Alarm 3 ¹	No alarm See Alarm 2 and 3 Code Table							N			
Contact input	Not supplied Contact input (RUN/STOP, Area select • Data set)							N	D		
Digital communications ²	Not supplied RS-232C (3-wire system : RKC standard) RS-422A (4-wire system : RKC standard) RS-485 (2-wire system : RKC standard) RS-485 (2-wire system : MODBUS) RS-422A (4-wire system : MODBUS) RS-232C (3-wire system : MODBUS)										N 4 5 6 7 8
Waterproof/Dustproof	Not supplied Waterproof/Dustproof protection										N 1
Instrument version	Version symbol										Y

- ¹ Alarm output is common to all channels.
² Heater break alarm and communication/contact input cannot be specified on the same hardware.
³ Heater break output is not available when either of control output is current output.

Range and Input Code Table

Thermocouple

Input	Code	Range	Input	Code	Range
K ¹	K : 01	0 - 200°C	J ¹	J : 22	0.0 - 200.0°C
	K : 02	0 - 400°C		J : 23	0.0 - 600.0°C
	K : 03	0 - 600°C		J : 30	-199.9 - 600.0°C
	K : 04	0 - 800°C		J : A1	0 - 800°F
	K : 05	0 - 1000°C		J : A2	0 - 1600°F
	K : 06	0 - 1200°C		J : A3	0 - 2192°F
	K : 07	0 - 1372°C	J : A6	0 - 400°F	
	K : 08	-199.9 - 300.0°C	J : A9	-199.9 - 999.9°F	
	K : 09	0.0 - 400.0°C	J : B6	0.0 - 800.0°F	
	K : 10	0.0 - 800.0°C	R ²	R : 01	0 - 1600°C
	K : 13	0 - 100°C		R : 02	0 - 1769°C
	K : 14	0 - 300°C		R : 04	0 - 1350°C
	K : 17	0 - 450°C		R : A1	0 - 3200°F
	K : 20	0 - 500°C	R : A2	0 - 3216°F	
	K : 29	0.0 - 200.0°C	S ²	S : 01	0 - 1600°C
	K : 37	0.0 - 600.0°C		S : 02	0 - 1769°C
	K : 38	-199.9 - 800.0°C		S : A1	0 - 3200°F
	K : A1	0 - 800°F	S : A2	0 - 3216°F	
	K : A2	0 - 1600°F	B ²	B : 01	400 - 1800°C
	K : A3	0 - 2502°F		B : 02	0 - 1820°C
K : A4	0.0 - 800.0°F	B : A1		800 - 3200°F	
K : A9	20 - 70°F	B : A2	0 - 3308°F		
K : B2	-199.9 - 999.9°F	E	E : 01	0 - 800°C	
J : 01	0 - 200°C		E : 02	0 - 1000°C	
J : 02	0 - 400°C		E : A1	0 - 1600°F	
J : 03	0 - 600°C	E : A2	0 - 1832°F		
J : 04	0 - 800°C	N	N : 01	0 - 1200°C	
J : 05	0 - 1000°C		N : 02	0 - 1300°C	
J : 06	0 - 1200°C		N : 06	0.0 - 800.0°C	
J : 07	-199.9 - 300.0°C		N : A1	0 - 2300°F	
J : 08	0.0 - 400.0°C		N : A2	0 - 2372°F	
J : 09	0.0 - 800.0°C	N : A5	0.0 - 999.9°F		
J : 10	0 - 450°C				

- ¹ Type K, J, T and U input : Accuracy is not guaranteed less than -100.0°C (-158.0°F)
² Type R, S and B input : Accuracy is not guaranteed between 0 to 399°C (0 to 799°F)
³ DC voltage input can be used for the input of 0 to 20mA (in case of 0 to 5V) and 4 to 20mA (1 to 5V) by attaching 250Ω shunt resistor (sold separately) to input terminal. (The model of shunt resistor : KD100-55)

RTD

Input	Code	Range
Pt100	D : 01	-199.9 - 649.0°C
	D : 02	-199.9 - 200.0°C
	D : 03	-100.0 - 50.0°C
	D : 04	-100.0 - 100.0°C
	D : 05	-100.0 - 100.0°C
	D : 06	0.0 - 50.0°C
	D : 07	0.0 - 100.0°C
	D : 08	0.0 - 200.0°C
	D : 09	0.0 - 300.0°C
	D : 10	0.0 - 500.0°C
	D : A1	-199.9 - 999.9°F
	D : A2	-199.9 - 400.0°F
	D : A3	-199.9 - 200.0°F
	D : A4	-199.9 - 100.0°F
	D : A5	-100.0 - 300.0°F
	D : A6	0.0 - 100.0°F
	D : A7	0.0 - 200.0°F
	D : A8	0.0 - 400.0°F
	D : A9	0.0 - 500.0°F
	JPt100	P : 01
P : 02		-199.9 - 200.0°C
P : 03		-100.0 - 50.0°C
P : 04		-100.0 - 100.0°C
P : 05		-100.0 - 200.0°C
P : 06		0.0 - 50.0°C
P : 07		0.0 - 100.0°C
P : 08		0.0 - 200.0°C
P : 09		0.0 - 300.0°C
P : 10		0.0 - 500.0°C

Voltage DC ³

Input	Code	Range
0-5V	4 : 01	0.0 - 100.0
0-10V	5 : 01	0.0 - 100.0
1-5V	6 : 01	0.0 - 100.0

Alarm 1 Code Table

Code	Type
A	Deviation High
B	Deviation Low
C	Deviation High/Low
D	Band Alarm
E	Deviation High with Alarm Hold

Code	Type
F	Deviation Low with Alarm Hold
G	Deviation High/Low with Alarm Hold
H	Process High
J	Process Low
K	Process High with Alarm Hold

Code	Type
L	Process Low with Alarm Hold
M	FAIL
R ¹	Loop break alarm (LBA)
V	Set value High
W	Set value Low

¹ Loop break alarm is not available for Heat/Cool PID control type.

Alarm 2 and 3 Code Table

Code	Type
A	Deviation High
B	Deviation Low
C	Deviation High/Low
D	Band Alarm
E	Deviation High with Alarm Hold

Code	Type
F	Deviation Low with Alarm Hold
G	Deviation High/Low with Alarm Hold
H	Process High
J	Process Low
K	Process High with Alarm Hold

Code	Type
L	Process Low with Alarm Hold
M	FAIL
V	Set value High
W	Set value Low

Accessory

Current transformer for heater break alarm

CTL-6-P-N (0 – 30A)

CTL-12-S56-10L-N (0 – 100A)

Shunt resistor for DC current input

KD100-55

Multi-Loop Digital Temperature Controller MA901

External Dimensions and Rear Terminals

Unit : mm

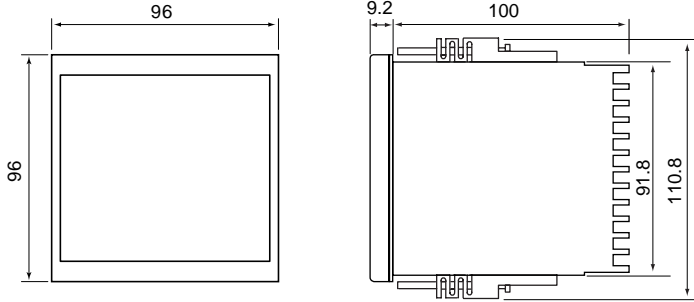

For mounting of the controllers, panel thickness must be between 1 to 10mm. When mounting multiple controllers close together, the panel strength should be checked to ensure proper support.

- Dustproof and waterproof are not effective when controllers are closely mounted.

Panel Cutouts

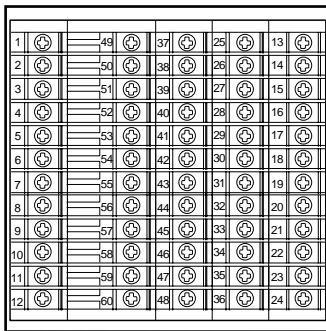

- Use the solder less terminal appropriate to the screw size.
- Screw size : M3 X 6

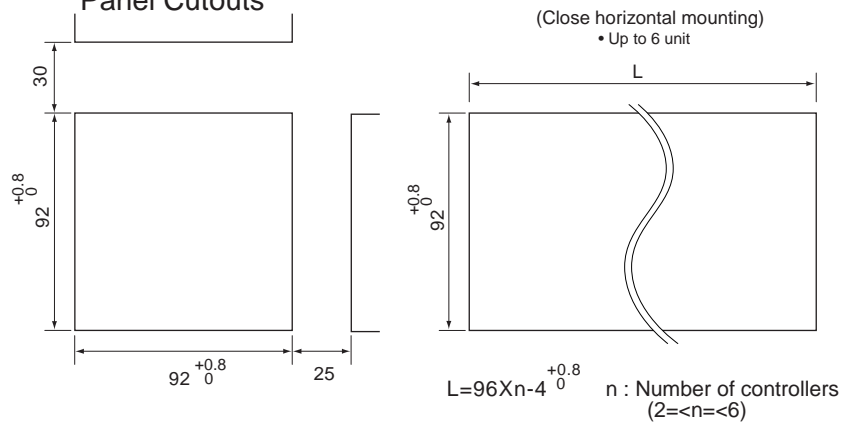

No.	Description
1	AC L DC + 100 to 240V 24V 24V - N - -
2	Power supply
3	NO
4	Alarm 1 output
5	NO
6	Output 1 (1) Relay contact (2) Voltage pulse/Current (3) Triac
7	NO
8	Output 2 (1) Relay contact (2) Voltage pulse/Current (3) Triac
9	NO
10	Output 3 (1) Relay contact (2) Voltage pulse/Current (3) Triac
11	NO
12	Output 4 (1) Relay contact (2) Voltage pulse/Current (3) Triac

No.	Description
49	NO
50	Alarm 2 output
51	NO
52	Alarm 3 output
53	NO
54	Output 5 (1) Relay contact (2) Voltage pulse/Current (3) Triac
55	NO
56	Output 6 (1) Relay contact (2) Voltage pulse/Current (3) Triac
57	NO
58	Output 7 (1) Relay contact (2) Voltage pulse/Current (3) Triac
59	NO
60	Output 8 (1) Relay contact (2) Voltage pulse/Current (3) Triac

<Heater break alarm type>

No.	Description
37	COM
38	CT1
39	CT2
40	COM
41	CT3
42	CT4
43	COM
44	CT5
45	CT6
46	COM
47	CT7
48	CT8

CT input for heater break alarm

No.	Description
25	A
26	B
27	(1) (2) (3)
28	A
29	B
30	(1) (2) (3)
31	A
32	B
33	(1) (2) (3)
34	A
35	B
36	(1) (2) (3)

No.	Description
13	A
14	B
15	(1) (2) (3)
16	A
17	B
18	(1) (2) (3)
19	A
20	B
21	(1) (2) (3)
22	A
23	B
24	(1) (2) (3)

<Contact input • Communications type>

No.	Description
37	DI
38	DI
39	COM
40	DI 1
41	DI 2
42	DI 4
43	DI SET
44	SG SG SG
45	T(A) T(R/A) SD
46	T(B) T(R/B) RD
47	R(A)
48	T(R/B)

Heater break alarm and communication/contact input cannot be specified on the same hardware.